



FEATURES

- RoHS compliant
- 1.0μH to 1mH
- Up to 11.8A I_{DC}
- Bobbin format
- Surface mount
- Integral EMI shield
- Compact size
- Tape and reel packaging
- UL 94V-0 materials
- J-STD-020-C reflow

DESCRIPTION

The 4900S series is a range of bobbin-wound, surface-mount inductors designed for use in switching power supply, and power line filter circuits. The parts are suitable for any application requiring a high saturation current in a low-profile package. The devices have an integral ferrite shield to reduce EMI.

PIN CONNECTIONS (TOP VIEW)

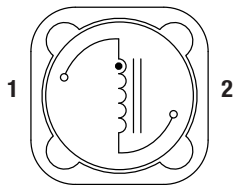

SELECTION GUIDE

| Order Code | Inductance (10kHz, 100mVAC) ±20% | DC Current ¹ | DC Resistance | SRF | Q Factor | |
|------------|--|-------------------------|---------------|-------------|-----------|-----------|
| | Nom. μH | Max. A | Max. mΩ | Typ. MHz | Typ. Q | |
| | | | | | | @ f (MHz) |
| 491R0SC | 1.0 (±30%) | 11.8 | 5 | 91 | 32 | 1 |
| 492R2SC | 2.2 (±30%) | 9.8 | 8 | 48 | 45 | 1 |
| 493R3SC | 3.3 (±30%) | 8.4 | 10 | 37 | 42 | 1 |
| 494R7SC | 4.7 (±30%) | 7.7 | 12 | 32 | 42 | 1 |
| 496R8SC | 6.8 (±30%) | 6.2 | 16 | 24 | 43 | 1 |
| 49100SC | 10 | 5.1 | 21 | 19 | 43 | 1 |
| 49150SC | 15 | 4.4 | 27 | 16 | 44 | 1 |
| 49220SC | 22 | 3.1 | 42 | 12 | 46 | 1 |
| 49330SC | 33 | 2.9 | 60 | 10 | 51 | 1 |
| 49470SC | 47 | 2.3 | 100 | 9 | 52 | 1 |
| 49680SC | 68 | 2.0 | 143 | 7 | 47 | 1 |
| 49101SC | 100 | 1.6 | 165 | 6 | 40 | 0.8 |
| 49151SC | 150 | 1.3 | 250 | 5 | 35 | 0.8 |
| 49221SC | 220 | 1.1 | 380 | 4 | 36 | 0.8 |
| 49331SC | 330 | 0.90 | 550 | 4 | 33 | 0.8 |
| 49471SC | 470 | 0.75 | 810 | 4 | 37 | 0.8 |
| 49681SC | 680 | 0.62 | 1200 | 3 | 27 | 0.8 |
| 49102SC | 1000 | 0.50 | 1500 | 3 | 26 | 0.8 |

MECHANICAL DIMENSIONS

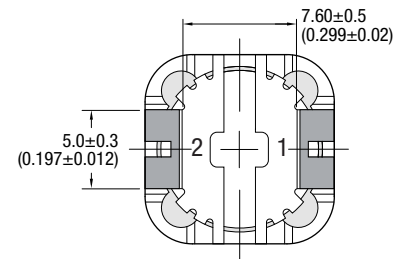
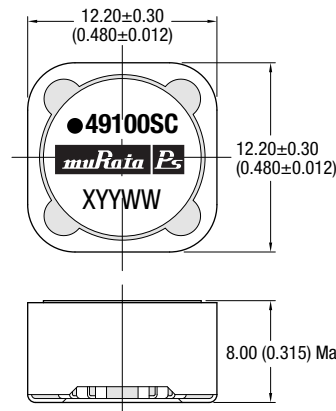

Recommended Footprint Details

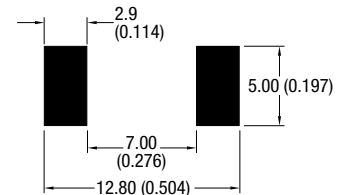

Dot signifies the innermost turn of the winding.
All dimensions in mm (inches). Package weight: 3.5g Typ.

ABSOLUTE MAXIMUM RATINGS

| | |
|--------------------------------------|----------------|
| Operating free air temperature range | -40°C to 85°C |
| Storage temperature range | -40°C to 125°C |

SOLDERING INFORMATION²

| | |
|--------------------------------|-------|
| Peak reflow solder temperature | 245°C |
| Pin finish | Tin |

Specifications typical at T_a = 25°C

- 1 Maximum DC current occurs when either the inductance falls to 75% of its nominal value or when its temperature rise reaches 40°C, whichever is sooner.
- 2 For further information, please visit www.murata-ps.com/rohs



INDUCTANCE Vs CURRENT

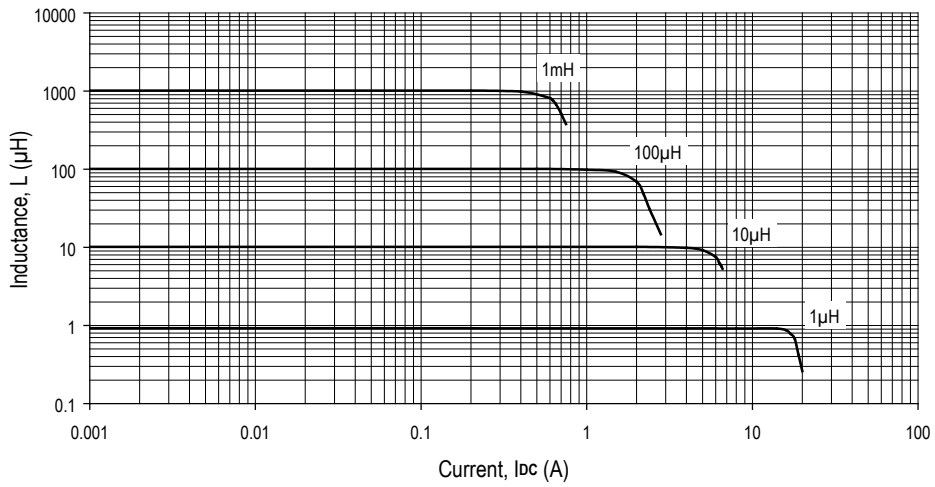

TEMPERATURE Vs CURRENT

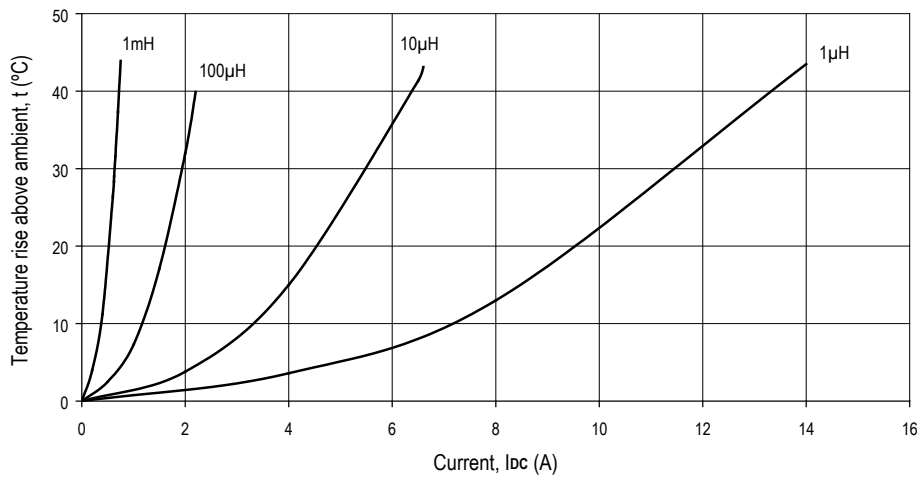

INDUCTANCE Vs FREQUENCY

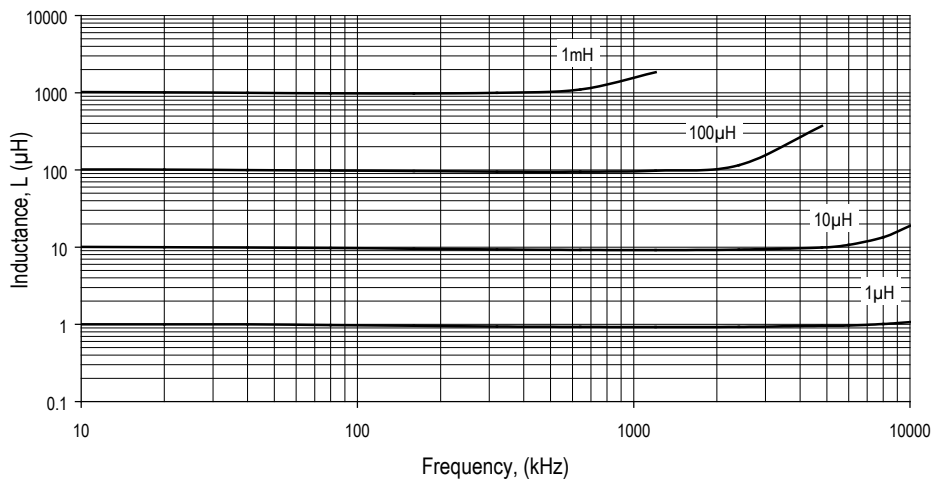

TAPE & REEL SPECIFICATIONS

REEL OUTLINE DIMENSIONS

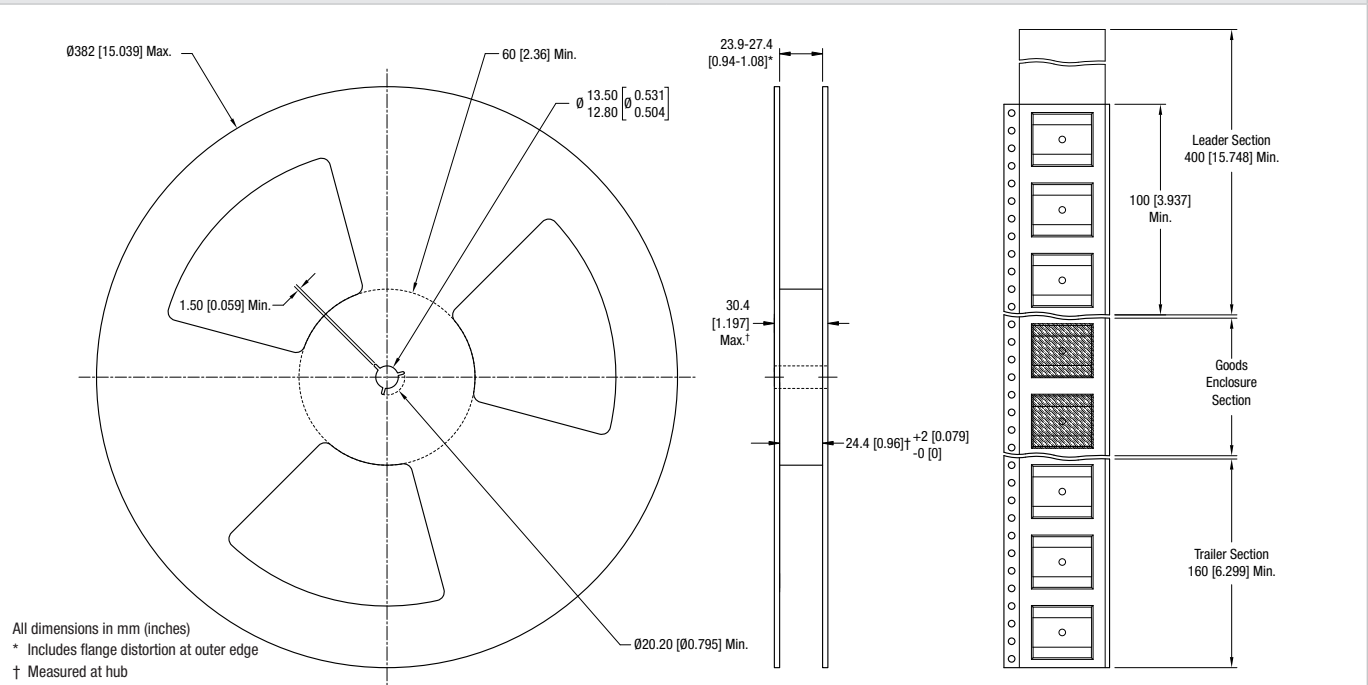

TAPE OUTLINE DIMENSIONS

